



2021.11

CABLE CHAINS AND FLEXIBLE CABLES

OVERVIEW

BREVETTI STENDALTO'S SIX POINTS



FAST REPLY
to any doubt or clarification
required.



DURABLE QUALITY
to guarantee maximum
reliability.



AVAILABILITY
of a warehouse always well
stocked.



INTERNATIONAL CERTIFICATIONS
to be present on all markets.



WIDE RANGE
to find the most suitable product
for any application.



INNOVATION
to propose state-of-the-art
solutions.

BREVETTI STENDALTO

Brevetti Stendalto was born in 1968 out of Giovanni Mauri's brilliant intuition that dynamic cable and hose protection would soon become paramount in machinery industry. He designed and marketed a cable chain made of nylon, much more lightweight, functional and cost-effective than traditional steel chains.

Since the beginning, Brevetti Stendalto has fostered innovation in products through big investments in Research and Development. The desire to meet, or rather anticipate, market needs has inspired Brevetti's constant evolution over more than 50 years, with an ever-increasing range of products.

Technology, innovation and evolution have always been the bywords of a company that started out as a small family business and rapidly evolved into a multi-national group with six branch offices and more than 130 employees worldwide. Markets such as industrial robotics, material working machines, automatic warehouses, port cranes and offshore cannot do without Brevetti Stendalto cable chains.

Still to these days Giovanni Mauri, with his daughter Laura and his son Claudio, **leads a company that has developed an important partnership with customers and has been able to maintain a serene and productive work environment,** based on trust and motivation among people.



SERIE LIGHT AND MEDIUM

Versatile design for application in automation, industrial machinery, and light equipment



Brevetti Stendalto today offers a wide range of products, suitable for the most demanding and most creative applications, thanks to a great experience achieved in various industrial fields. Attention to the design, precision in the engineering process, and quality applied to production, make Brevetti products highly eclectic: chains can work both in self-supporting and sliding configurations, always providing the highest performance standards.

[MORE INFO](#)

SERIE LIGHT: SINGLE-LINK CONSTRUCTION NOT OPENABLE

Inner height from 12 mm to 35 mm



SERIE LIGHT: SINGLE-LINK OPENABLE INNER/OUTER RADIUS

Inner height from 18 mm to 35 mm



SERIE MEDIUM: DOUBLE-SHARE SINGLE-LINK CONSTRUCTION

Inner height from 18 mm to 31 mm



SERIE MEDIUM: CHAIN WITH SIDEBANDS AND HOLDING PINS

Inner height from 35 mm to 75 mm



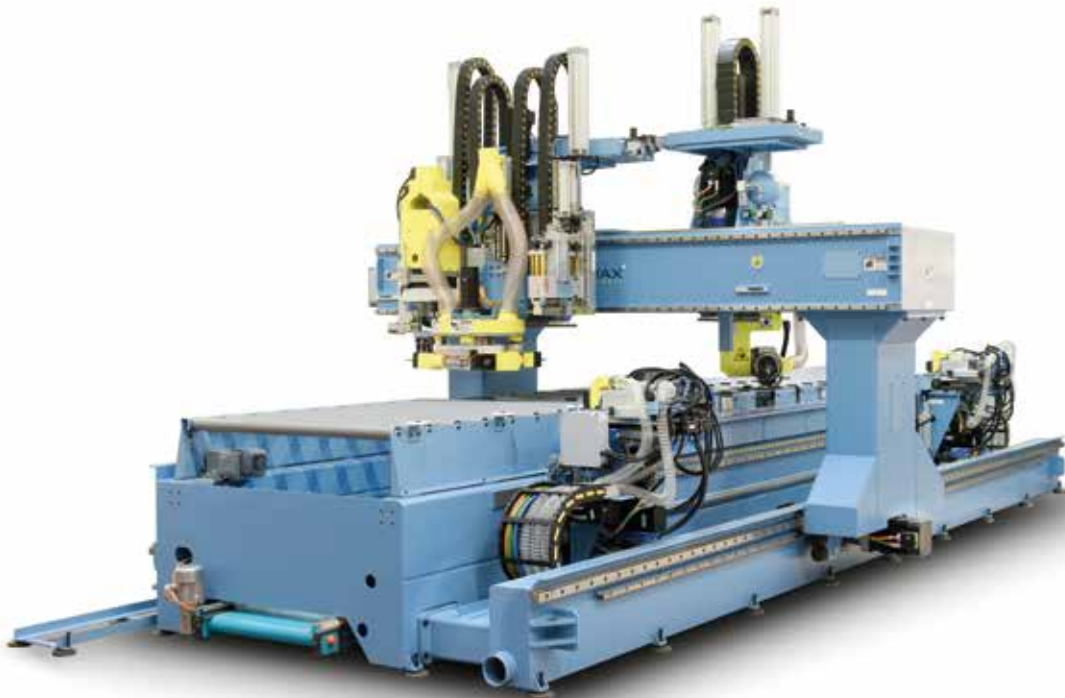

SERIE PROTECTION

Fully enclosed design for increased safeguard of utilities



MORE INFO

Protecting cables and hoses is Brevetti Stendalto's core business, and this is exactly what Serie Protection does. Mainly used on machine tools, Brevetti's Protection chains prevent hot chips and dirt from getting inside the chain and damaging cables and hoses. Many OEMs in the world have experienced the quality of Brevetti chains, with or without the iconic yellow pins. Pins as well as chains may be customised with the customer's company colours.

SERIE PROTECTION WITH OPENABLE NYLON COVERS

Inner height from 25 mm to 77 mm



SERIE PROTECTION WITH OPENABLE ALUMINIUM COVERS

Inner height from 45 mm to 107 mm

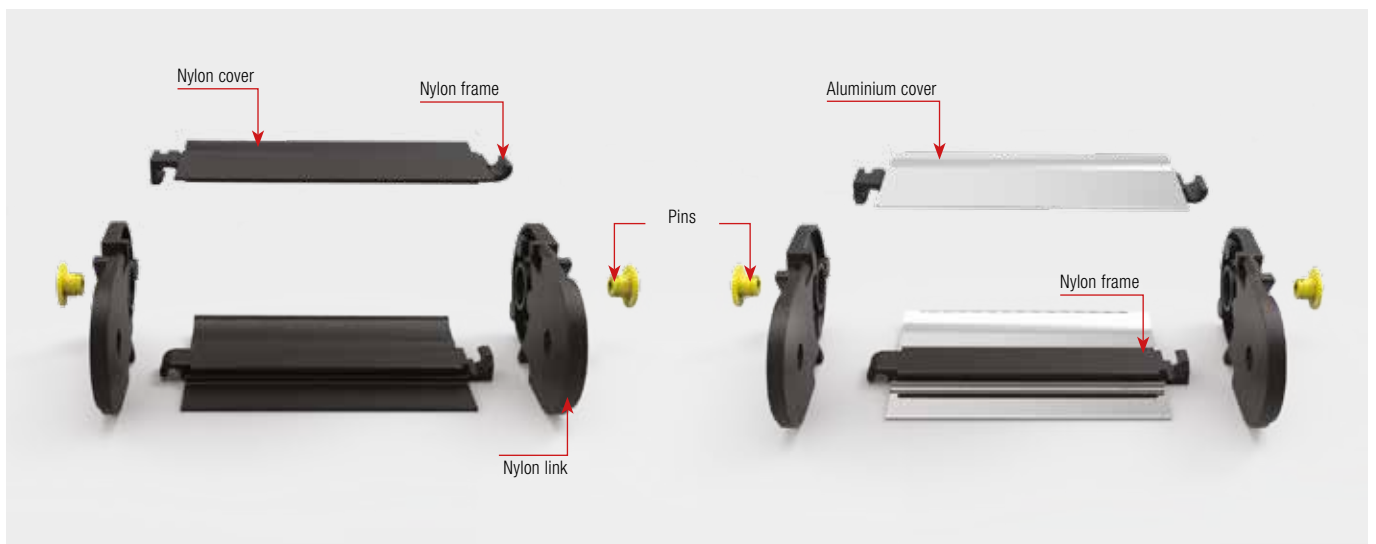
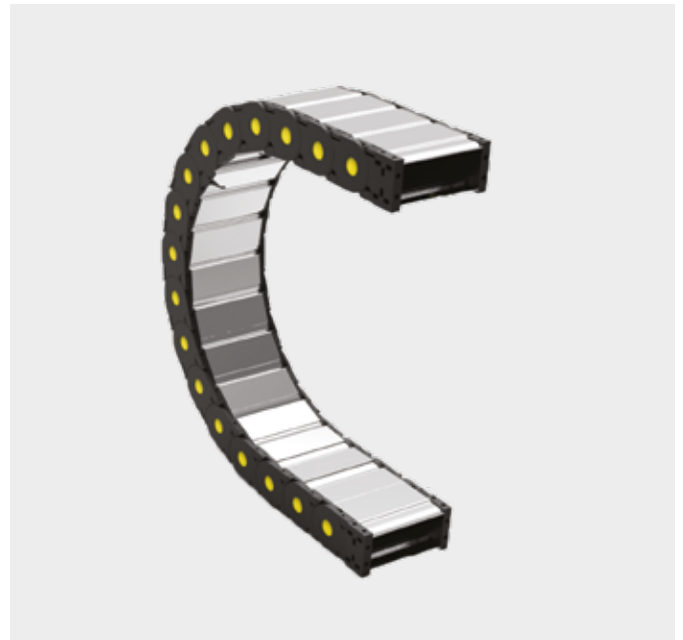

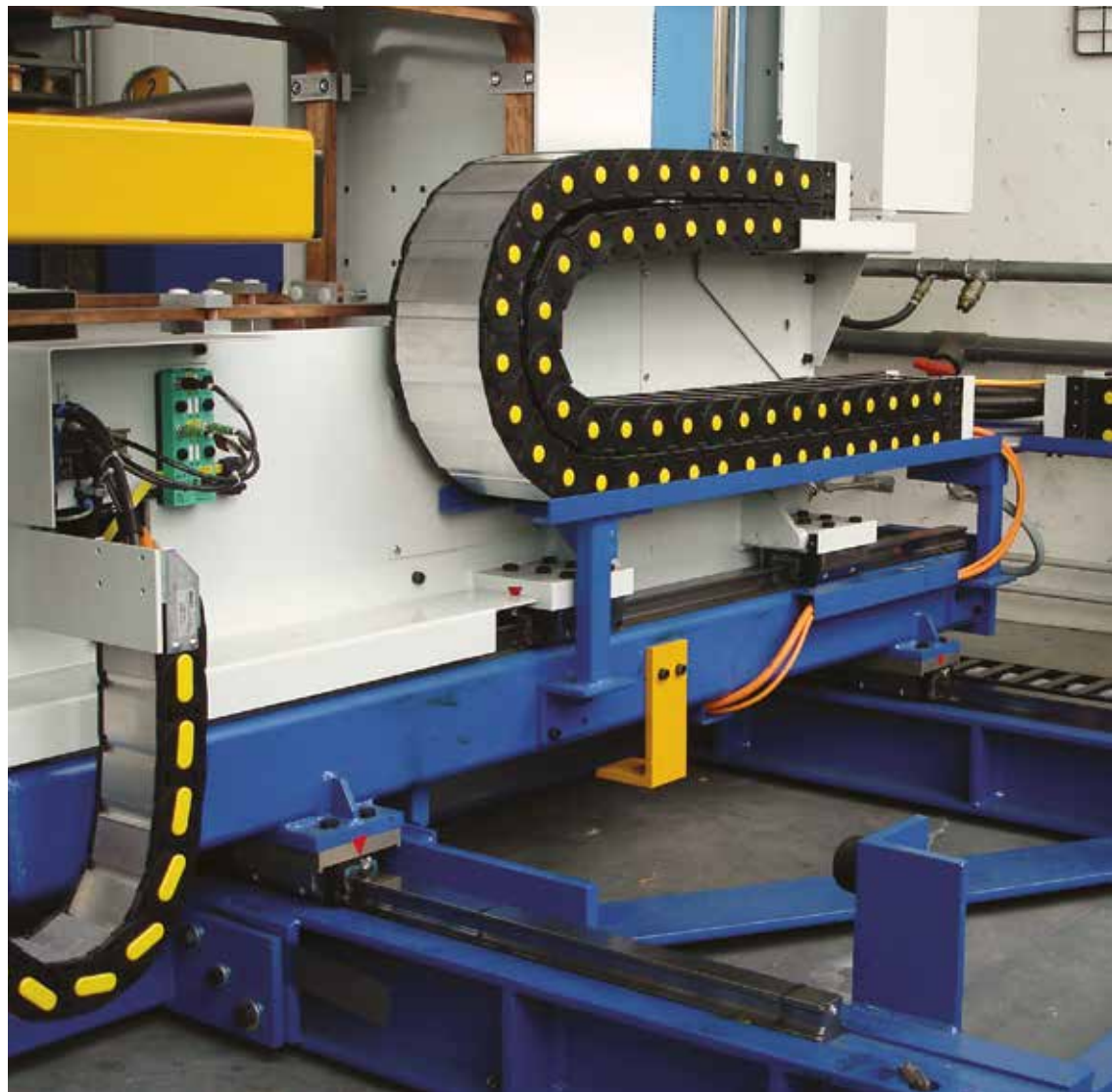

SERIE HEAVY AND STEEL

Strong design for application in harsh environment



MORE INFO

Brevetti Stendalto's heavy-duty cable chains are high-performance nylon and steel chains. Chains of the Heavy and Steel series are designed to offer the best performance in the harshest environments and with the heaviest loads. The experience with nylon and steel chains accumulated over many decades on international markets allows Brevetti to guide customers to the selection of the most suitable product. Heavy and Steel chains can be customised in countless ways: stainless-steel rods, machined aluminium crosspieces, special bend radius and counter-radius, specific cable segregation.

NYLON "H" SERIES

Brevetti's "H" Series provides increased strength compared to traditional Heavy chains. All components of the H chains are designed with improved robustness.



STEEL "L" SERIES

Brevetti's innovative Y-link design for Steel chains reduces chain weight without compromising performances.

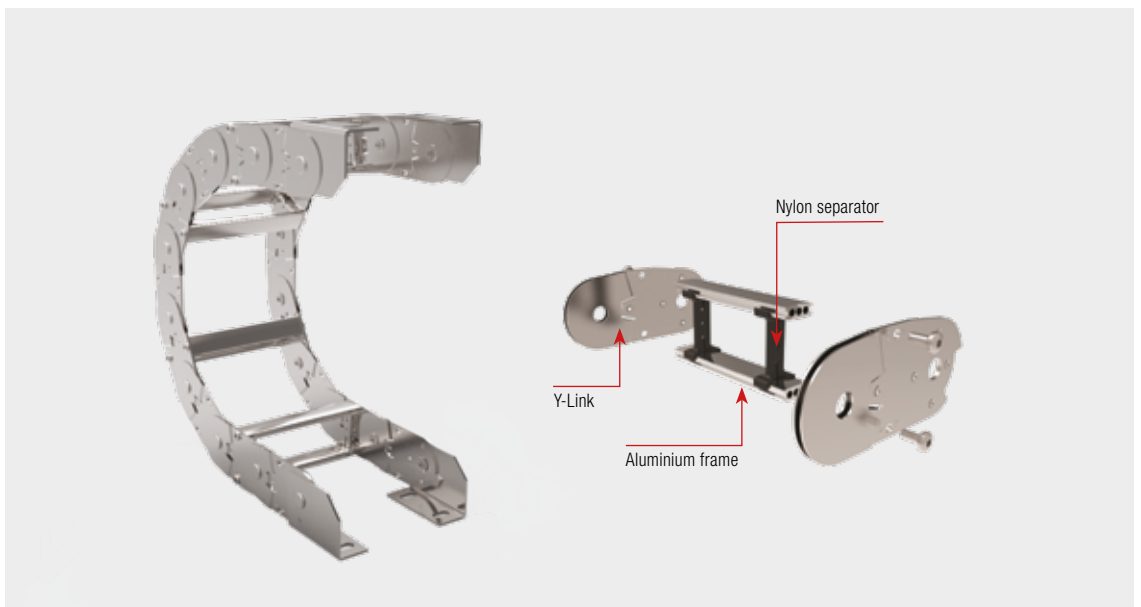

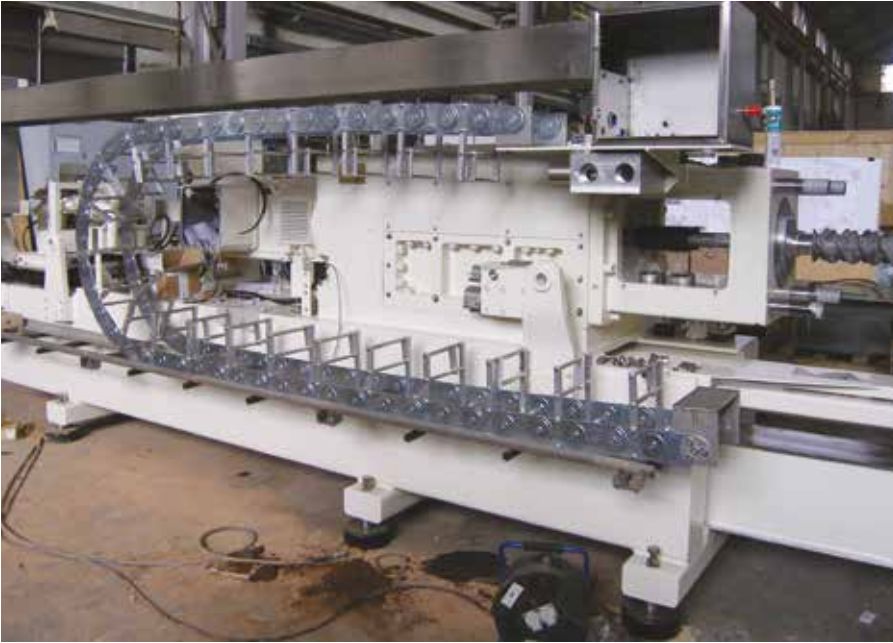

SERIE SLIDING

Special design for long-travel applications



MORE INFO

Brevetti's Sliding chains were developed to cover any travel distance that would reach beyond self-supporting capacity. Beside traditional Sliding chains, Brevetti introduced the "invisible roller" IR-Chain technology. IR-Chains feature a wider sliding surface, as well as integrated pop-up wheels that appear only when needed. Brevetti's innovative IR-Chain technology is the right solution for extremely long travel, high speed, heavy added load, or otherwise demanding applications. IR-Chains offer great reliability, minimum wearing, and easy maintenance.



NYLON SKID

Integrated or interchangeable skids increase durability even with high load and speed



80PU - 60PU

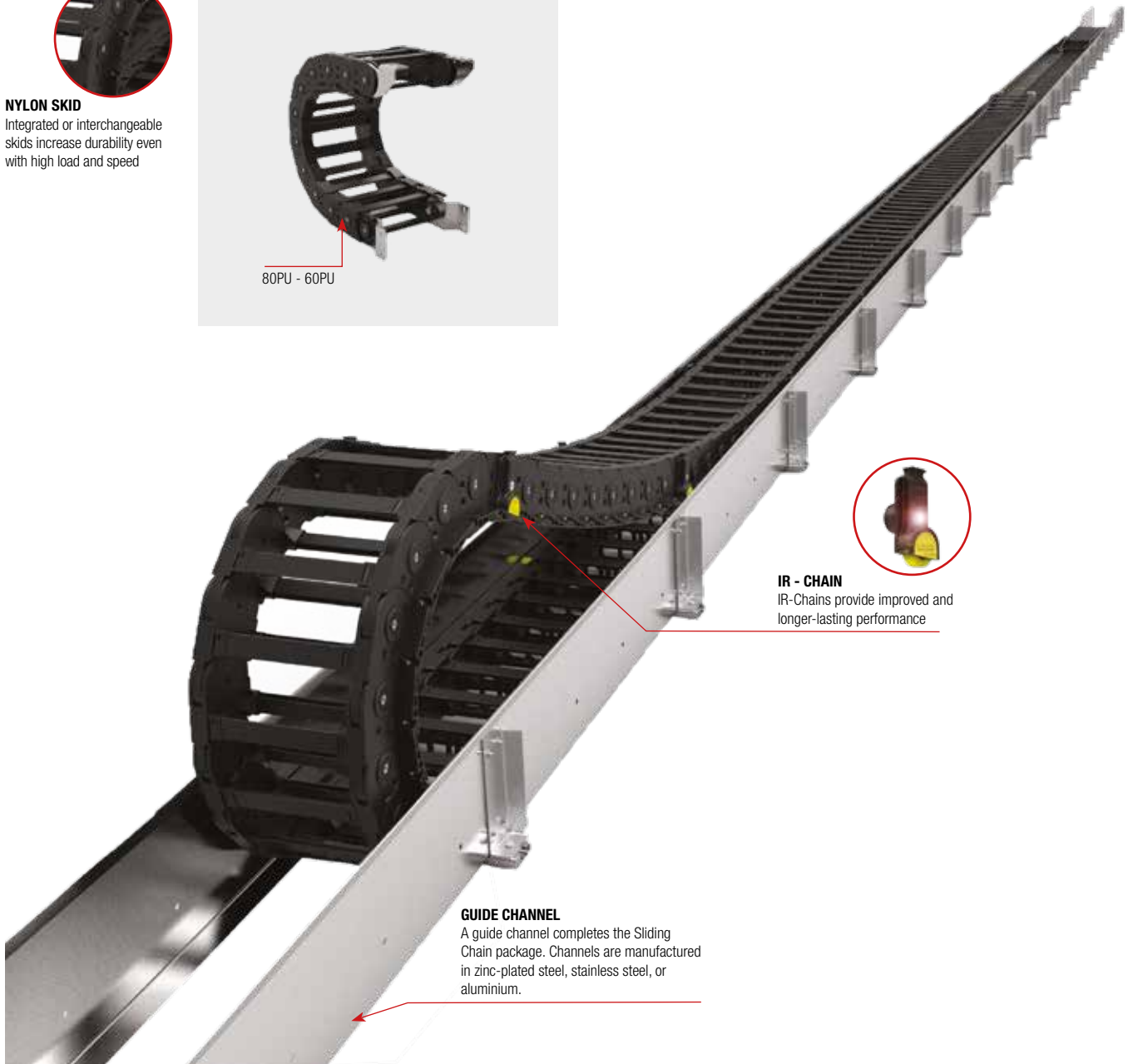

IR - CHAIN

IR-Chains provide improved and longer-lasting performance

GUIDE CHANNEL

A guide channel completes the Sliding Chain package. Channels are manufactured in zinc-plated steel, stainless steel, or aluminium.



TOTAL CHAIN

Fully harnessed cable chain



MORE INFO

Brevetti Stendalto's Total Chain is the plug-and-play system where the chain is pre-assembled with connectorized cables and hoses with fittings, and delivered to customers ready for installation. Brevetti can be a system integrator by providing all-in-one cable-chain systems for a wide range of applications, including industrial automation, packaging, machine tools, textile industry, wood, marble and glass machining, transfer machinery, workbenches, etc. ... anything that can be harnessed!



ADVANTAGES

- Reduced assembly time.
- One single interlocutor/supplier.
- Warranty given over the full system.
- A simple and reliable solution.

COST EFFECTIVENESS

- Quicker and more efficient ordering process.
- Order the exact amount needed.
- No unused warehouse stock.
- Technical documentation: Brevetti uses state-of-the-art 2D and 3D CAD software to develop functional and construction drawings, datasheets, BOMs and technical instructions.

PACKAGING

Brevetti's plug-and-play Total Chain systems are rolled up on transportation drums or secured to lifting frames, for fast and easy installation.



UTILITIES

Brevetti cables are extra-flexible, specifically designed for use with cable chains, and may be provided with connectors. A large selection of flexible industrial and hydraulic hoses with fittings is also available.





SERIE ROBOT, MULTIFLEX AND MRS

Cable chain for application on robots and machinery with 3d movement



MORE INFO

Brevetti Stendalto has revolutionised since 1989 the concept of circular chains introducing the chains from the Robot series that, due to the particular construction of the links, permit them to rotate up to 540°. Multiflex and MRS (Multiflex Retraction System) enriches Brevetti's Serie Robot and presents customers with the opportunity to receive a complete dress package for their application from a single supplier.

Multiflex chain is the solution for multi-dimensional movements, with special focus on robotics and new-generation machining centers. Multiflex is fully closed, but quick to open and easy to populate thanks to covers that can be removed with a normal screwdriver.

MRS (Multiflex Retraction System) is a spring-driven retraction system that makes hoses and cables work in perfect adherence and synchrony with the robot arm, from axis 3 to axis 6, without collisions and breakdowns, and increasing their working life.

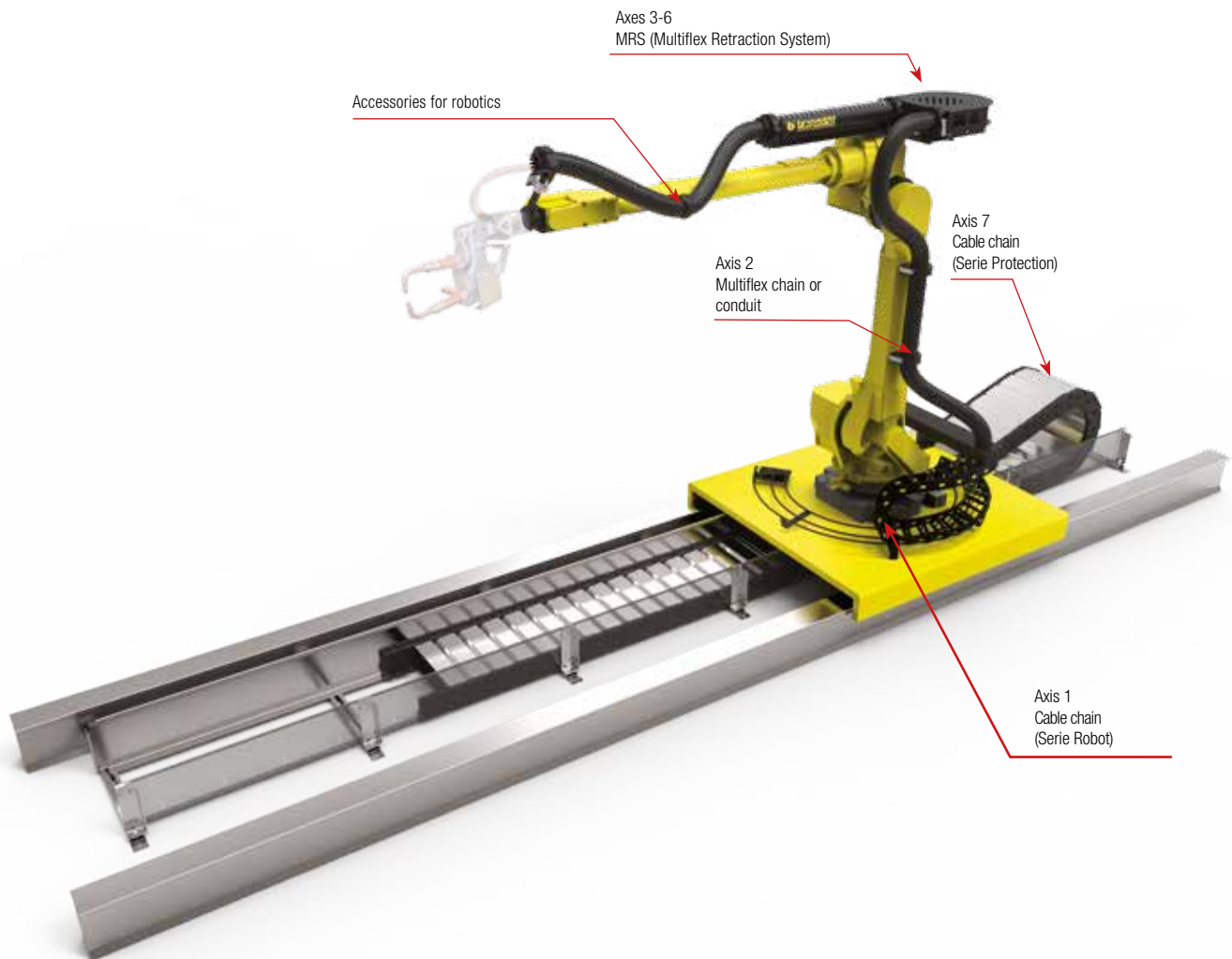

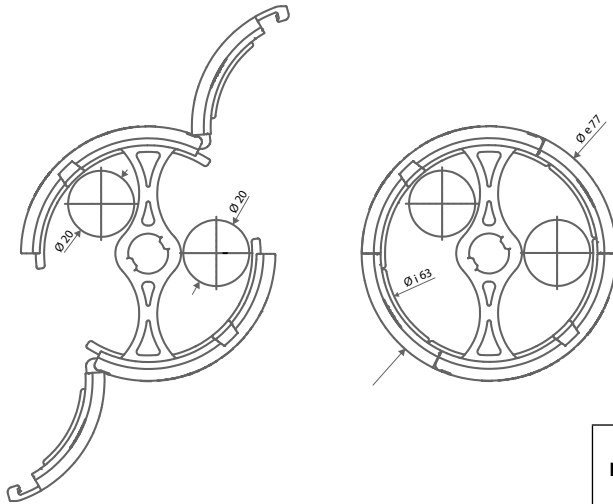

Ø Inner mm	Ø Outer mm	Min. radius mm	Pitch mm	N. Pitches/m	Kg/m	Twist angle	Cable housing
63 mm	77 mm	100 mm	18.5	54	1,6	~±10° *	M. Ø 20 mm

* Defined as the single links



CABLE CHAIN PRODUCT RANGE

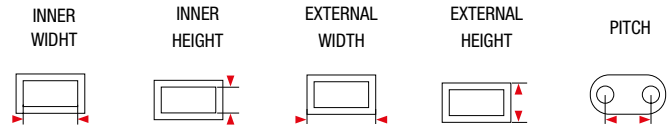

	DA mm	TO mm	DA mm	TO mm	DA mm	TO mm	mm	mm
200	12	35	12	-	18	41	15	17
250L/LI/LE	15	50	17	-	26	61	23	29
30090/91/92	18	38	18,5	-	29	49	23,5	30
325LI/LE	40	103	25	-	57	120	38	45
325L	40	103	25	-	57	120	38	45
335L/LI/LE	40	150	35	-	56,5	166,5	50	52
339	40	76	39	-	60	96	50	35

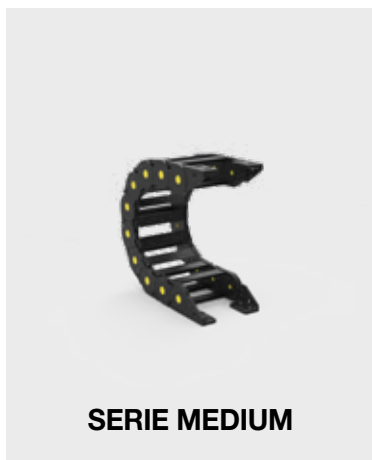

300A	15	75	18	-	27	87	23	30
300	14	36	18	-	30	52	23	30
305A	30	50	24	-	54	74	30	35
305	30	50	23	-	52	72	30	35
355A	45	95	31	-	74	124	43	40
355	45	95	30	-	74	124	45	40
400	40	60	25	-	62	82	35	40
435MU	40	150	35	-	60	170	49	50
445MU	50	362	45	-	72	384	64	67
660A	50	362	37	-	75	387	55	50
770A	45	357	60	-	80	392	78	70
475MU	74	498	75,5	-	112	536	100,5	105

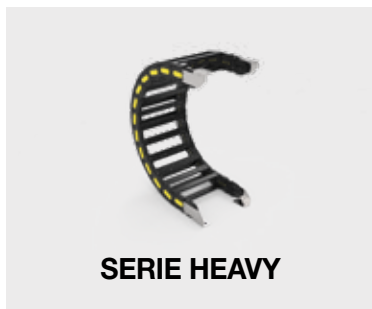

H57	75	500	57	-	113	538	85	90
H80	64	400	70	75,5	120	456	100	120
H110	200	600	112	-	260	660	150	160
306	43	355	30	37	79	391	55	65
307	42	354	40	47	80	392	64	70
308	38	350	48	57	82	394	75	80
309	64	400	70	75,5	120	456	100	100
310	200	600	112	-	260	660	150	145



325PI	10	103	25	-	57	120	38	45
335PS	40	150	35	-	56,5	166,5	50	52
435PU	40	150	35	-	60	170	48	50
445PU	50	362	45	-	72	384	64	67
445PS	61	125	45	-	83	147	64	67
445AU	50	362	45	-	72	384	64	67
475PU	74	374	75,5	-	110	410	100,5	105
660	50	150	36	-	79	179	55	50
770	85	250	51	-	120	285	78	70
306CU	43	355	37	-	79	391	55	65
308CU	38	350	57	-	82	394	75	80
309C	200	400	72	-	256	456	100	100
309CU	64	488	75,5	-	120	544	100	100

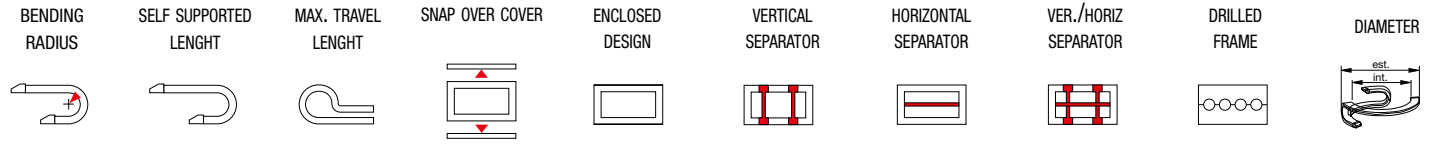

DA mm	TO mm	MAX m	KG		INNER mm	OUTER mm						INNER mm	OUTER mm
18	40	0,90	0,1	-	-	-	-	-	-	-	-	-	-
28	100	1,30	0,1	-	•	•	-	○	-	-	-	-	-
33	100	1,45	0,1	○	-	-	-	-	-	-	-	-	-
50	150	1,90	0,5	○	•	•	-	○	-	-	-	-	-
50	150	1,90	0,5	○	-	-	-	○	-	-	-	-	-
65	200	2,20	1	○	•	•	-	○	-	-	-	-	-
50	100	2,20	1	○	-	-	-	○	-	-	-	-	-

40	120	1,70	0,1	-	•	-	-	-	-	-	-	-	-
40	120	1,55	0,1	○	-	-	-	-	-	-	-	-	-
50	150	1,40	1	-	•	•	-	○	-	-	-	-	-
50	150	1,90	1	○	-	-	-	○	-	-	-	-	-
75	200	2,30	1	-	•	•	-	○	-	-	-	-	-
75	200	2,30	1	○	-	-	-	○	-	-	-	-	-
50	150	1,60	1	-	•	•	-	○	-	-	-	-	-
60	200	2,20	1	○	•	•	-	○	-	-	-	-	-
75	300	3,70	1	○	•	•	-	○	○	○	-	-	-
100	250	2,45	1	○	•	•	-	○	○	○	-	-	-
150	300	3,80	1	○	•	•	-	○	○	○	-	-	-
150	400	4,75	1	○	•	•	-	○	○	○	-	-	-

150	400	5,00	1	-	•	•	○	○	○	○	○	-	-
200	750	6,00	1	-	•	•	○	○	○	○	○	-	-
200	750	9,00	1	-	•	•	○	○	○	○	○	-	-
75	300	3,10	1	-	•	•	○	○	○	○	○	-	-
75	250	3,90	1	-	•	•	○	○	○	○	○	-	-
150	400	4,95	1	-	•	•	○	○	○	○	○	-	-
200	500	6,50	1	-	•	•	○	○	○	○	○	-	-
200	750	7,00	1	-	•	•	○	○	○	○	○	-	-

75	150	1,70	0,5	-	•	-	•	○	○	○	-	-	-
65	200	2,00	1	-	•	-	-	○	-	-	-	-	-
75	200	2,10	1	-	•	•	•	○	○	○	-	-	-
100	300	3,35	1	-	•	•	•	○	○	○	-	-	-
100	300	3,35	1	•	•	•	•	○	○	○	-	-	-
100	300	3,35	1	-	•	•	•	○	○	○	-	-	-
180	400	4,45	1	-	•	•	•	○	○	○	-	-	-
100	250	2,30	1	-	•	-	•	○	○	○	-	-	-
150	300	3,45	1	-	•	-	•	○	○	○	-	-	-
107	300	2,70	1	-	•	•	•	○	○	○	-	-	-
180	400	4,00	1	-	•	•	•	○	○	○	-	-	-
200	500	5,80	1	-	-	•	•	○	○	○	-	-	-
200	500	6,00	1	-	•	•	•	○	○	○	-	-	-

• = STANDARD ○ = ON REQUEST

CABLE CHAIN PRODUCT RANGE

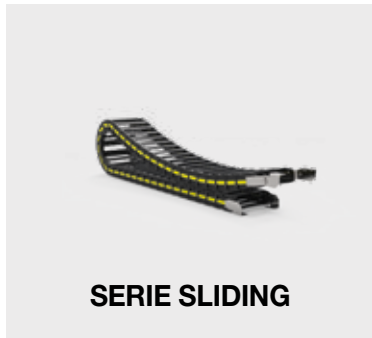
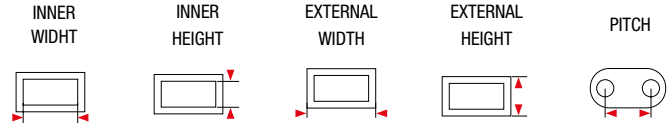

	DA mm	TO mm	DA mm	TO mm	DA mm	TO mm	mm	mm
326	61	373	30	37	89	416	59	65
328	61	373	48	57	116	428	79	80
319	64	400	70	75,5	128	464	107	100
329	64	488	75,5	-	128	552	107	100
478	74	498	75,5	-	112	536	106,5	105
60PU	115	539	60,5	-	165	589	90	90
80PU	115	539	80,5	-	195	619	117	110



495	45	-	35	-	69	-	45	-
500	65	-	30	-	93	-	43	-
510TN	88	-	46	-	132	-	55-77	-
515TN	88	-	46	-	132	-	55-77	-
545	62	-	46	-	123	-	62	-
599	210	-	59	-	272	-	85	-



20LT	79	304	32	-	111	336	53	75
20LC	79	304	32	-	111	336	53	75
30LT	106	506	52	58	140	540	74	95
30LC	106	506	52	-	140	540	74	95
35LT	104	504	65	70	148	548	95	125
35LC	104	504	65	-	148	548	95	125
40LT	150	500	112,5	-	208	558	145	180
40LC	150	500	112,5	-	208	558	145	180
42LT	150	500	138	-	208	558	175	180
45T	300	600	182	180	390	690	220	250
20NT	79	304	32	38	112	337	53	75
30NT	106	306	52	58	142	342	74	95
35NT	104	404	65	70	153	453	95	125
35NC	104	404	65	-	153	453	95	125

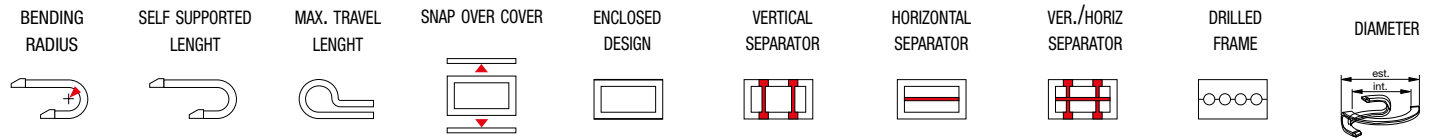

DA mm	TO mm	MAX m	KG		INNER mm	OUTER mm						INNER mm	OUTER mm
107	300	-	-	•	•	•	○	○	○	○	○	-	-
150	400	-	-	•	•	•	○	○	○	○	○	-	-
200	500	-	-	•	•	•	-	○	○	○	○	-	-
150	600	-	-	•	•	•	○	○	○	○	-	-	-
150	400	-	-	•	•	•	○	○	○	○	-	-	-
150	400	-	-	•	•	•	-	○	○	○	-	-	-
200	700	-	-	•	•	•	-	○	○	○	-	-	-

100	-	-	-	-	•	-	-	-	-	-	-	600	755
100	150	-	-	-	•	-	-	○	-	-	-	630	830
125	-	-	-	-	•	-	-	•	-	-	-	940	1220
175	-	-	-	-	•	-	-	•	-	-	-	1060	1340
100	-	-	-	-	•	-	-	•	○	○	-	485	760
220	-	-	-	-	•	•	-	•	○	○	-	1400	2000

75	305	3,90	1	○	-	-	○	•	○	○	-	-	-
115	305	4,20	1	○	-	-	○	•	○	○	-	-	-
150	535	5,50	1	-	-	-	○	○	○	○	•	-	-
150	535	5,00	1	-	-	-	•	○	○	○	-	-	-
200	600	7,25	1	-	-	-	○	○	○	○	•	-	-
200	600	7,00	1	-	-	-	•	○	○	○	-	-	-
250	850	12,90	1	○	-	-	○	○	○	○	•	-	-
250	850	11,8	1	○	-	-	•	○	○	○	-	-	-
250	850	12	1	○	-	-	-	○	○	○	-	-	-
400	1500	13,00	1	-	-	-	○	○	○	○	•	-	-
75	305	5,40	1	○	-	-	○	○	○	○	•	-	-
150	535	6,20	1	○	-	-	○	○	○	○	•	-	-
200	600	9,10	1	○	-	-	○	○	○	○	•	-	-
200	600	8,90	1	○	-	-	•	○	○	○	-	-	-

• = STANDARD ○ = ON REQUEST

BREVETTI STENDALTO ON THE WEB



MORE INFO

Brevettistendalto.com is a modern website, easy to navigate, always up-to-date and customer-friendly. The website includes a company presentation, information on product range, application in various fields, detailed data on all products and comparison between products. The online configurator on our website contains all components and accessories, including cables, and allows customers to create their own chain systems. The tool is easy to use and accompanies the customer from the initial project phase to placing an order in just a few steps. Our technical department is always available to provide expert suggestions.



OUR CABLES WORLD



MORE INFO

Brevetti Stendalto offers a wide range of cables, specifically designed for long-lasting performance with cable chains. Brevetti's signal, power, BUS and FO cables in PVC and PUR/PP are the right choice for any application, work environment and certification. Thanks to insourced assembly activities, Brevetti is able to deliver cables already inserted in chains, to provide customers with the most complete service and the guarantee of a controlled and certified quality.

The cable range includes:

- MULTICONDUCTOR AND MULTIPAIR CONTROL CABLES
- POWER CABLES
- ENCODER, MEASURING SYSTEM AND RESOLVER CABLES
- BUS CABLES
- FIBRE OPTIC CABLES
- SERVO-MOTOR CABLES











CERTIFICATIONS



FLEXIBLE CABLE PRODUCT RANGE

	OUTER SHEATH	INSULATION	SHIELD	PAIR'S SHIELD	NUMBER OF CORES	CORE SECTION (from - to mm ²)	BENDING RADIUS Self-supporting (factor x Ø)	MAX. SPEED (m/min)	MAX. ACCELERATION (m/s ²)	STATIC TEMPERATURE RANGE (°C)	
PAIRS AND MULTICONDUCTOR CABLES	BC406-P	PVC	PP	-	-	2 - 37	0.25 - 0.34	6.5 - 7.5	300	20	-40° / +80°
	BC407-P	PVC	PP	•	-	2 - 37	0.25 - 0.34	6.5 - 7.5	300	20	-40° / +80°
	BC468	PVC	PP	-	-	2 - 25	0.50 - 6	6.5 - 10	300	20	-40° / +80°
	BC469	PVC	PP	•	-	2 - 25	0.50 - 6	6.5 - 10	300	20	-40° / +80°
	BC418-P	PUR	PP	-	-	3 - 36	0.34 - 2.5	5	600	60	-50° / +80°
	BC419-P	PUR	PP	•	-	3 - 25	0.25 - 2.5	5	600	60	-50° / +80°
	BC412	PVC	PP	•	-	4 - 12	0.25 - 0.34	6.5 - 7.5	300	20	-40° / +80°
	BC413	PUR	PP	•	-	4 - 20	0.14 - 0.34	6.5 - 7.5	600	60	-50° / +80°
	BC417	PUR	PP	•	-	4 - 24	0.50 - 2.5	10	240	20	-50° / +80°
POWER AND SERVO-MOTOR CABLES	BC420N-P	PUR	PP	-	-	4-5	2.5 - 35	7.5	240	20	-50° / +80°
	BC421N-P	PUR	PP	•	-	4	4 - 35	7.5	600	60	-50° / +80°
	BC423LC	PVC	PP	•	-	4	1.5 - 50	7.5	300	20	-40° / +80°
	BC423ALC	PVC	PP	•	-	6	1.5 - 50	7.5	300	20	-40° / +80°
	BC421LC	PUR	PP	•	-	4	1.5 - 50	6.5 - 10	600	60	-50° / +80°
	BC430LC	PUR	PP	•	-	4-8	0.75 - 50	6.5 - 10	600	60	-50° / +80°
	BC435LC	PUR	PP	•	-	6	1.5 - 50	6.5 - 10	600	60	-50° / +80°
	BC427-P	PVC	XL-PE	-	-	1	6 - 95	6.5 - 7.5	300	20	-40° / +80°
	BC427C-P	PVC	XL-PE	•	-	1	6 - 95	6.5 - 7.5	300	20	-40° / +80°
	BC425-P	PUR	PP	-	-	1	10 - 240	7.5	600	60	-40° / +80°
	BC426-P	PUR	PP	•	-	1	10 - 240	7.5	600	60	-40° / +80°
	BC428PE	PUR	PP	-	-	3+3	50 - 95	7.5	240	10	-50° / +80°
	BC429PE	PUR	PP	•	-	3+3	50 - 70	7.5	240	10	-50° / +80°
ENCODER, MEASURING SYSTEM AND RESOLVER CABLES	BC4400001	PUR	PP	•	-	12	0.25 - 1	6.5 - 10	600	60	-50° / +80°
	BC4400020	PUR	PP	•	-	10	0.25 - 0.50	6.5 - 10	600	60	-50° / +80°
	BC4400018	PVC	PP	•	-	12	0.38 - 0.50	6.5 - 10	300	20	-40° / +80°
	BC4400002	PUR	PP	•	-	12	0.38 - 0.50	6.5 - 10	600	60	-50° / +80°
	BC4400004	PUR	PP	•	-	12	0.14 - 1	6.5 - 10	600	60	-50° / +80°
	BC4400017	PUR	PP	•	•	8	0.14 - 0.50	6.5 - 10	600	60	-50° / +80°
	BC4400005	PUR	PP	•	-	12	0.14 - 0.50	6.5 - 10	600	60	-50° / +80°
	BC4400007	PVC	PP	-	•	8	0.25	6.5 - 10	300	20	-40° / +80°
	BC4400008	PVC	PP	-	•	8	0.34	6.5 - 10	300	20	-40° / +80°
	BC4400009	PVC	PP	•	•	8	0.25	6.5 - 10	300	20	-40° / +80°
	BC4400010	PVC	PP	•	•	8	0.34	6.5 - 10	300	20	-40° / +80°
	BC4400006	PUR	PP	•	-	12	0.14 - 0.22	6.5 - 10	600	60	-50° / +80°
	BC4400016	PVC	PP	•	-	12	0.38 - 0.50	6.5 - 10	300	20	-40° / +80°
	BC4400019	PVC	PP	•	-	16	0.14 - 0.22	6.5 - 10	300	20	-40° / +80°

DYNAMIC TEMPERATURE RANGE (°C)	OPERATING VOLTAGE (V)	TESTING VOLTAGE (V)	MUD RESISTANT	FLAME RESISTANT	OIL RESISTANT	CERTIFICATION									
															
-25° / +80°	300	1500	-	•	•	•	•	•	•	•	•	-	•	•	•
-25° / +80°	300	1500	-	•	•	•	•	•	•	•	•	-	•	•	-
-25° / +80°	600/1000	4000	-	•	•	•	•	•	•	•	•	-	•	•	-
-25° / +80°	600/1000	4000	-	•	•	•	•	•	•	•	•	-	•	•	-
-40° / +80°	300/1000	1500/4000	•	•	•	•	•	•	•	•	•	-	•	•	•
-40° / +80°	300/1000	1500/4000	•	•	•	•	•	•	•	•	•	-	•	•	•
-25° / +80°	300	1500	-	•	•	•	•	•	•	•	•	-	•	•	-
-40° / +80°	300	1500	•	•	•	•	•	•	•	•	•	-	•	•	•
-40° / +80°	1000	4000	-	•	•	•	•	•	•	•	•	-	-	•	•
-40° / +80°	600/1000	4000	•	•	•	•	•	•	•	•	•	-	•	•	•
-40° / +80°	600/1000	4000	•	•	•	•	•	•	•	•	•	-	•	•	•
-25° / +80°	600/1000	4000	-	•	•	•	•	•	•	•	•	•	•	•	-
-25° / +80°	600/1000	4000	-	•	•	•	•	•	•	•	•	-	•	•	-
-40° / +80°	600/1000	4000	•	•	•	•	•	•	•	•	•	•	•	•	•
-40° / +80°	600/1000	4000	•	•	•	•	•	•	•	•	•	•	•	•	•
-25° / +80°	600/1000	4000	-	•	•	•	•	•	•	•	•	-	•	•	-
-25° / +80°	600/1000	4000	-	•	•	•	•	•	•	•	•	-	•	•	-
-20° / +80°	600/1000	4000	-	•	•	•	•	-	-	•	•	-	•	-	-
-20° / +80°	600/1000	4000	-	•	•	•	•	-	-	•	•	-	•	-	-
-40° / +80°	600/1000	4000	•	•	•	•	•	•	•	•	•	-	•	•	•
-40° / +80°	600/1000	4000	•	•	•	•	•	•	•	•	•	-	•	•	•
-40° / +80°	300	1500	•	•	•	•	•	•	•	•	•	•	•	•	•
-40° / +80°	300	1500	•	•	•	•	•	•	•	•	•	•	•	•	•
-25° / +80°	300	1500	•	•	•	•	•	•	•	•	•	•	•	•	-
-40° / +80°	30	500	•	•	•	•	•	•	•	•	•	•	•	•	•
-40° / +80°	300	1500	•	•	•	•	•	•	•	•	•	•	•	•	•
-40° / +80°	300	1500	•	•	•	•	•	•	•	•	•	•	•	•	•
-40° / +80°	300	1500	•	•	•	•	•	•	•	•	•	•	•	•	•
-25° / +80°	300	1500	-	•	•	•	•	•	•	•	•	•	•	•	-
-25° / +80°	300	1500	-	•	•	•	•	•	•	•	•	•	•	•	-
-25° / +80°	300	1500	-	•	•	•	•	•	•	•	•	•	•	•	-
-25° / +80°	300	1500	-	•	•	•	•	•	•	•	•	•	•	•	-
-40° / +80°	300	1500	•	•	•	•	•	•	•	•	•	•	•	•	•
-25° / +80°	300	1500	-	•	•	•	•	•	•	•	•	•	•	•	-
-25° / +80°	300	1500	-	•	•	•	•	•	•	•	•	•	•	•	-











FLEXIBLE CABLE PRODUCT RANGE

	OUTER SHEATH	INSULATION	SHIELD	PAIR'S SHIELD	NUMBER OF CORES	CORE SECTION (from - to mm ²)	BENDING RADIUS Self-supporting (factor x \emptyset)	MAX. SPEED (m/min)	MAX. ACCELERATION (m/s ²)	STATIC TEMPERATURE RANGE (°C)	
ENCODER, MEASURING SYSTEM AND RESOLVER CABLES	BC4400011	PUR	PP	•	•	8	0.25	6.5 - 10	600	60	-50° / +80°
	BC4400012	PUR	PP	•	•	6	0.34	6.5 - 10	600	60	-50° / +80°
	BC4400013	PUR	PP	•	•	8	0.34	6.5 - 10	600	60	-50° / +80°
	BC4400014	PUR	PP	•	•	6	0.25	6.5 - 10	600	60	-50° / +80°
	BC4400015	PUR	PP	•	-	9	0.50	6.5 - 10	600	60	-50° / +80°
	BC4400023	PUR	PP	•	-	12	0.14 - 0.50	6.5 - 10	600	60	-50° / +80°
	BC4400024	PUR	PP	•	-	8	0.14 - 0.34	6.5 - 10	600	60	-50° / +80°
	BC4400025	PVC	PP	•	-	8	0.14 - 0.34	6.5 - 10	300	20	-40° / +80°
	BC4400022	PUR	PP	•	-	16	0.18	6.5 - 10	600	60	-50° / +80°

HARDNESSED SERVO-MOTOR CABLES	BTC423LC	PVC	PP	•	-	4	1.5 - 50	7.5	300	20	-40° / +80°
	BTC423ALC	PVC	PP	•	-	6	1.5	7.5	300	20	-40° / +80°
	BTC440	PVC	PP	-	-	12	0.14 - 0.50	6.5 - 10	600	60	-50° / +80°
	BTC421LC	PUR	PP	•	-	4	1.5 - 50	6.5 - 10	600	60	-50° / +80°
	BTC435LC	PUR	PP	•	-	6	1.5 - 50	6.5 - 10	600	60	-50° / +80°
	BTC440	PVC	PP	-	-	12	0.14 - 0.50	10	600	60	-50° / +80°

BUS CABLES	BC4500003	PUR	PP	•	-	2	22 AWG	10	240	20	-50° / +80°
	BC4500017	PUR	PP	•	-	2	24 AWG	10	240	20	-50° / +80°
	BC4500005	PVC	PP	•	-	6	0.22	10	300	20	-40° / +80°
	BC4500007	PUR	PP	•	•	4	22/24 AWG	10	600	60	-50° / +80°
	BC4500014	PUR	PP	•	•	4	15/18 AWG	10	600	60	-50° / +80°
	BC4500020	PUR	PP	•	-	4	22 AWG	10	600	60	-50° / +80°
	BC4500022-C5	PUR	PP	•	-	8	24/27 AWG	10	600	60	-40° / +80°
	BC4500023	PUR	PP	•	-	8	26 AWG	10	600	60	-50° / +80°
	BC4500024	PUR	PP	•	•	8	26 AWG	10	600	60	-50° / +80°
	BC4500012	PUR	PP	•	-	4	0.34	10	600	60	-50° / +80°
	BC4500015	PUR	PP	•	-	2	24 AWG	10	600	60	-50° / +80°

	OUTER SHEATH	NUMBER OF FIBER	CONSTRUCTION	MAX. SPEED (m/min)	MAX. ACCELERATION (m/s ²)	DYNAMIC TEMPERATURE RANGE (°C)	BENDING RADIUS Self-supporting	STATIC APPLICATION	BANDWIDTH 50/125 μ m	
OPTIC FIBERS	BC500	LSZH	6 - 24	•	180	10	-20° / +60°	10	•	400
	BC520	PUR	6 - 24	•	180	10	-25° / +80°	10	•	500

DYNAMIC TEMPERATURE RANGE (°C)	OPERATING VOLTAGE (V)	TESTING VOLTAGE (V)	MUD RESISTANT	FLAME RESISTANT	OIL RESISTANT	CERTIFICATION									
															
-40° / +80°	300	1500	•	•	•	•	•	•	•	•	•	•	•	•	•
-40° / +80°	300	1500	•	•	•	•	•	•	•	•	•	•	•	•	•
-40° / +80°	300	1500	•	•	•	•	•	•	•	•	•	•	•	•	•
-40° / +80°	300	1500	•	•	•	•	•	•	•	•	•	•	•	•	•
-40° / +80°	300	1500	•	•	•	•	•	•	•	•	•	•	•	•	•
-40° / +80°	30	500	•	•	•	•	•	•	•	•	•	•	•	•	•
-40° / +80°	300	1500	-	•	•	•	•	•	•	•	•	•	•	•	-
-25° / +80°	300	1500	-	•	•	•	•	•	•	•	•	•	•	•	-
-40° / +80°	300	1500	•	•	•	•	•	•	•	•	•	•	•	•	•

-25° / +80°	600/1000	4000	-	•	•	•	•	•	•	•	•	•	•	•	-
-25° / +80°	600/1000	4000	-	•	•	•	•	•	•	•	•	•	•	•	-
-40° / +80°	300	1500	•	•	•	•	•	•	•	•	•	•	•	•	•
-40° / +80°	600/1000	4000	•	•	•	•	•	•	•	•	•	•	•	•	•
-40° / +80°	600/1000	4000	•	•	•	•	•	•	•	•	•	•	•	•	•
-40° / +80°	300	1500	•	•	•	•	•	•	•	•	•	•	•	•	•

-40° / +80°	30	500	150	-	•	•	•	•	•	•	•	•	•	•	•	•
-40° / +80°	30	500	150	-	•	•	•	-	-	-	-	-	•	-	-	-
-25° / +80°	30	500	100	-	•	•	•	•	•	•	•	•	-	•	•	-
-40° / +80°	300	1500	120	-	•	•	•	•	•	•	•	•	•	•	•	•
-40° / +80°	300	1500	120	-	•	•	•	•	•	•	•	•	•	•	•	•
-40° / +80°	300	1500	100	-	•	•	•	•	•	•	•	•	•	•	•	•
-40° / +80°	30	500	100	•	•	•	•	•	•	•	•	•	•	-	-	•
-40° / +80°	30	500	100	-	•	•	•	•	•	•	•	•	•	•	•	•
-40° / +80°	30	500	100	-	•	•	•	•	•	•	•	•	•	•	•	•
-40° / +80°	30	500	120	-	•	•	•	•	•	•	•	•	•	•	•	•
-40° / +80°	30	500	120	-	•	•	•	•	•	•	•	•	•	•	•	•

BANDWIDTH 50/125 μm	BANDWIDTH 62.5/125 μm	ATTENUATION 50/125 μm	ATTENUATION 62.5/125 μm	FLAME RESISTANT	FIRE RETARDANT	WATER RESISTANT	GASES EMISSION	SMOKE EMISSION	CERTIFICATION	
										
800	160	500	3.5	1	2.8	0.8	•	•	•	•
500	200	500	3.5	1	2.8	0.8	•	-	•	•

OUR CUSTOMIZED SOLUTIONS

OFFSHORE PLATFORMS

In the longitudinal movement of movable derricks, the travel distance usually overcomes the maximum self-supporting capacity of the chain, even if supported by rollers. It is therefore necessary to use two chains in ring configuration, supported by a movable trolley.

POSSIBLE CONFIGURATIONS

Double, triple, multiple side-bands. Every single crossbar can be opened for easy installation and maintenance of hoses and cables

DESIGN

Our chains are maintenance-free. Every component is designed to guarantee performance for the whole work life of the chain - at least 25 years

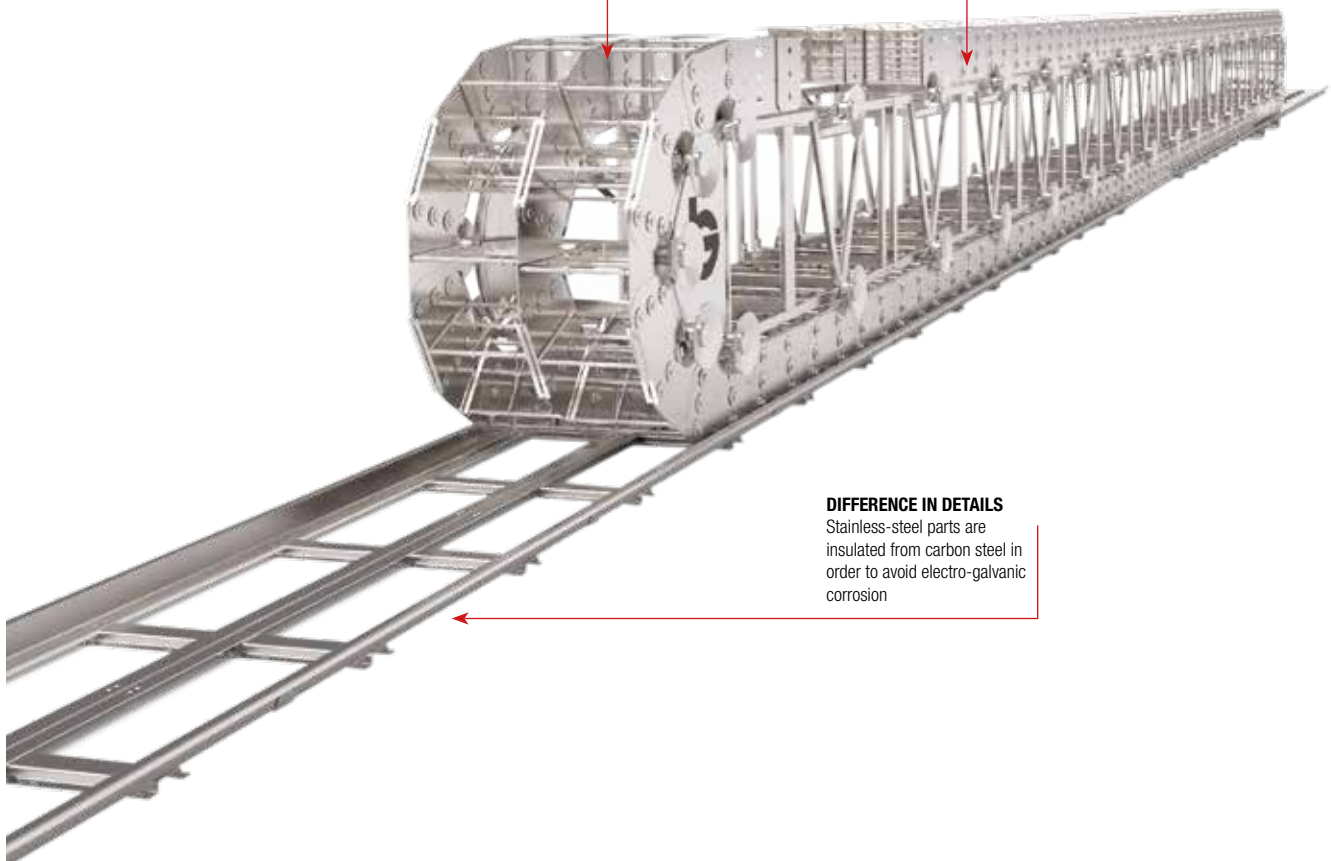

DIFFERENCE IN DETAILS

Stainless-steel parts are insulated from carbon steel in order to avoid electro-galvanic corrosion

LARGE TELESCOPES

Brevetti's rotary solutions are always designed for full integration into customers' machines, and match the specific technical requirements of every application. We can deliver our rotary systems either with mono-block frames or with concentric moving frames. A movable trolley is usually provided for a more stable and safer guidance of the chains under operation.

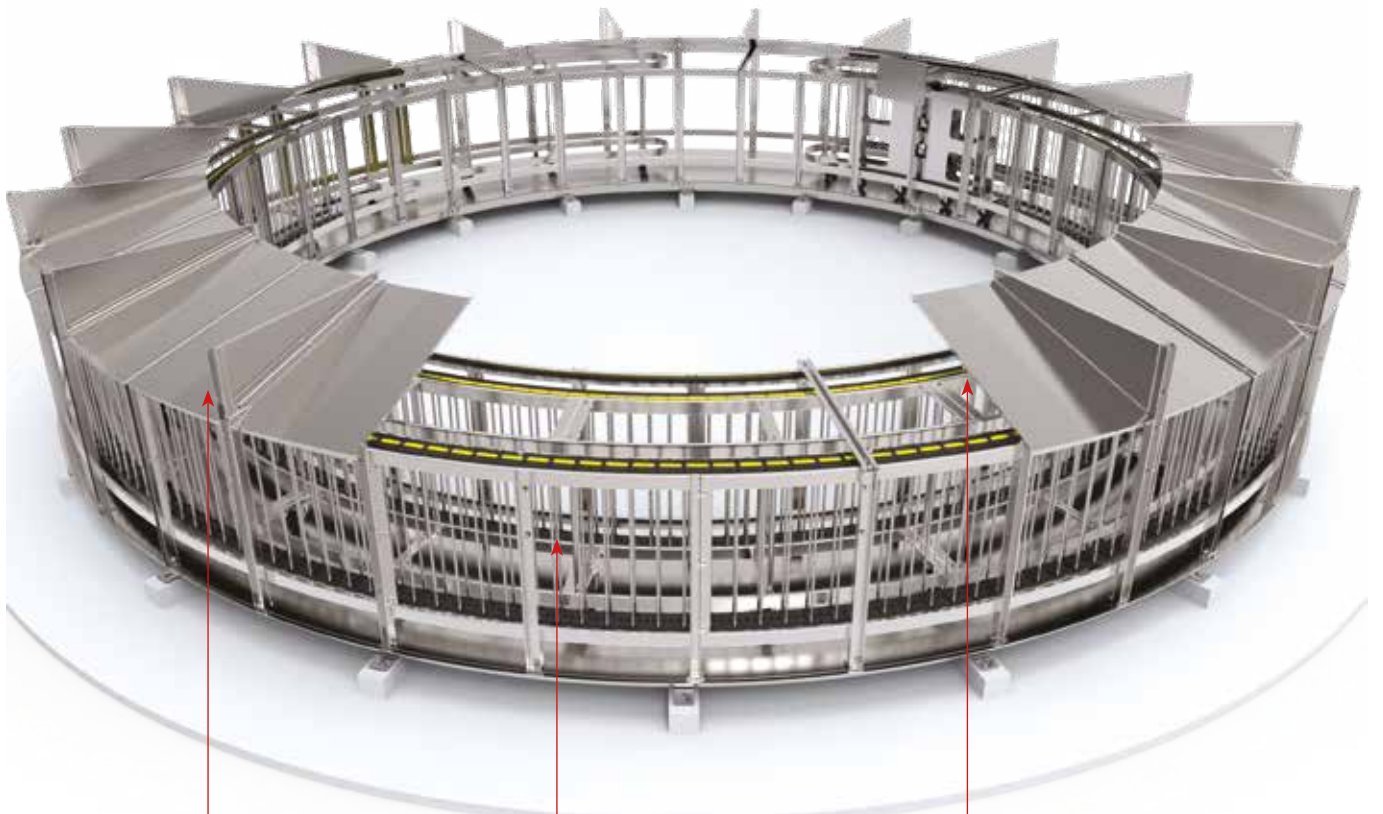

STEEL FRAMES

We can design fully-enclosed systems against falling objects

GUIDE HOUSING

Wheels guarantee smooth, low-friction movement of the system between the trolley and the chains

ROTATIONAL NYLON CHAIN

Nylon sidebands in combination with stainless-steel crossbars for maximum load capacity



Brevetti Stendalto S.p.A.

Viale G.B. Stucchi 66/8
20900 Monza (MB)

Tel. +39 039 204901

Fax +39 039 834250

info@brevettistendalto.it
www.brevettistendalto.it



Brevetti Stendalto
worldwide